



Operating Instructions

WARNING

To reduce the risk of fire or electric shock, do not expose the TV to rain or moisture.



This symbol is intended to alert the user to the presence of uninsulated “dangerous voltage” within the product’s enclosure that may be of sufficient magnitude to constitute a risk of electric shock to persons.



This symbol is intended to alert the user to the presence of important operating and maintenance (servicing) instructions in the literature accompanying the appliance.

Note to the CATV Installer

This reminder is provided to call the CATV system installer’s attention to Article 820-40 of the NEC that provides guidelines for proper grounding and, in particular, specifies that the cable ground shall be connected to the grounding system of the building as close to the point of cable entry as practical.

SAFETY PRECAUTIONS

- Operate the TV only on 120 V AC.
- One blade of the power plug is wider than the other for safety purposes and will fit into the power outlet only one way. If you are unable to insert the plug fully into the outlet, contact your dealer.
- If any liquid or solid object falls into the TV, unplug it and have it checked by qualified personnel before operating it further.

CAUTION

When using TV games, computers, and similar products with your TV, keep the brightness and contrast functions at low settings. If a fixed (non-moving) pattern is left on the screen for long periods of time at a high brightness or contrast setting, the image can be permanently imprinted onto the screen. Continuously watching the same channel can cause the imprint of station logos onto the TV screen. These types of imprints are not covered by your warranty because they are the results of misuse.



To reduce the risk of electric shock, do not use this polarized plug with an extension cord, receptacle, or other outlet unless the blades can be fully inserted to prevent blade exposure.



You are cautioned that any changes or modifications not expressly approved in this manual could void your authority to operate this equipment.

NOTIFICATION

This equipment has been tested and found to comply with the limits for a Class B digital device pursuant to Part 15 of the FCC Rules. These limits are designed to provide reasonable protection against harmful interference in a residential installation. This equipment generates, uses, and can radiate radio frequency energy and, if not installed and used in accordance with the instructions, may cause harmful interference with radio communications. However, there is no guarantee that interference will not occur in a particular installation. If this equipment does cause harmful interference to radio or television reception, which can be determined by turning the equipment off and on, the user is encouraged to try to correct the interference by one or more of the following measures:

- Reorient or relocate the receiving antennas.
- Increase the separation between the equipment and receiver.
- Connect the equipment into an outlet on a circuit different from that to which the receiver is connected.
- Consult the dealer or an experienced radio/TV technician for help.

Protecting the TV

- To prevent internal heat build-up, do not block the ventilation openings.
- Do not install the TV in a hot or humid place, or in a place subject to excessive dust or mechanical vibration.

Note on Caption Vision

This television receiver provides display of television closed captioning in accordance with § 15.119 of the FCC rules.

Use of this television for other than private viewing of programs broadcast on UHF or VHF or transmitted by cable companies for the use of the general public may require authorization from the broadcaster-cable company and/or program owner.

Owner’s Record

The model and serial numbers are located on the front cover of this manual and at the rear of your TV.

Trademarks and Copyrights

ENERGY STAR® is a registered mark.



As an ENERGY STAR® Partner, Sony has determined that this product or product model meets the ENERGY STAR® guidelines for energy efficiency.

Licensed by BBE Sound, Inc. under USP 4638258.4482866. BBE and BBE symbol are trademarks of BBE Sound, Inc.

“WOW, TruSurround, and the (●)® symbol are trademarks of SRS Labs, Inc. WOW technology is incorporated under license from SRS Labs, Inc.”

IMPORTANT SAFEGUARDS

For your protection, please read these instructions completely, and keep this manual for future reference. Carefully observe and comply with all warnings, cautions and instructions placed on the set, or described in the operating instructions or service manual.

WARNING

To guard against injury, the following basic safety precautions should be observed in the installation, use, and servicing of the set.

Use

Power Sources

This set should be operated only from the type of power source indicated on the serial/model plate. If you are not sure of the type of electrical power supplied to your home, consult your dealer or local power company. For those sets designed to operate from battery power, refer to the operating instructions.



Grounding or Polarization

This set is equipped with a polarized AC power cord plug (a plug having one blade wider than the other), or with a three-wire grounding type plug (a plug having a third pin for grounding). Refer to the following instructions:

For the set with a polarized AC power cord plug

This plug will fit into the power outlet only one way. This is a safety feature. If you are unable to insert the plug fully into the outlet, try reversing the plug. If the plug still fails to fit, contact your electrician to have a suitable outlet installed. Do not defeat the safety purpose of the polarized plug by forcing it in.



Alternate Warning

For the set with a three-wire grounding type AC plug

This plug will only fit into a grounding-type power outlet. This is a safety feature. If you are unable to insert the plug into the outlet, contact your electrician to have a suitable outlet installed. Do not defeat the safety purpose of the grounding plug.

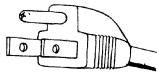

Overloading

Do not overload wall outlets, extension cords or convenience receptacles beyond their capacity, since this can result in fire or electric shock.

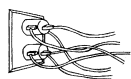

Always turn the set off when it is not to be used. When the set is left unattended and unused for long periods of time, unplug it from the wall outlet as a precaution against the possibility of an internal malfunction that could create a fire hazard.

Do not disconnect the antenna or the power cord during a heavy storm. Lightning may strike while you are holding the cable or cord, causing serious injury. Turn off your TV and wait for the weather to improve.



Object and Liquid Entry

Never push objects of any kind into the set through the cabinet slots as they may touch dangerous voltage points or short out parts that could result in a fire or electric shock. Never spill liquid of any kind on the set.



Attachments

Do not use attachments not recommended by the manufacturer, as they may cause hazards.

Do not place any objects, especially heavy objects, on top of the set. The object may fall from the set, causing injury.

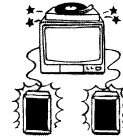

Cleaning

Unplug the set from the wall outlet before cleaning or polishing it. Do not use liquid cleaners or aerosol cleaners. Use a cloth lightly dampened with water for cleaning the exterior of the set.



If a snapping or popping sound from a TV set is continuous or frequent while the TV is operating, unplug the TV and consult your dealer or service technician. It is normal for some TV sets to make occasional snapping or popping sounds, particularly when being turned on or off.



Installation

Always use two or more people to lift or move the set. The set is heavy and the bottom surface is flat. Serious injury can result from trying to move the set by yourself alone, or from unsteady handling. Install the set on a stable, level surface.

Water and Moisture

Do not use power-line operated sets near water — for example, near a bathtub, washbowl, kitchen sink, or laundry tub, in a wet basement, or near a swimming pool, etc.



Accessories

Do not place the set on an unstable cart, stand, tripod, bracket, table, or shelf. The set may fall, causing serious injury to a child or an adult, and serious damage to the set. Use only a cart or stand recommended by the manufacturer for the specific model of TV. Any mounting of the product should follow the manufacturer's instructions, and should use a mounting accessory recommended by the manufacturer. An appliance and cart combination should be moved with care. Quick stops, excessive force, and uneven surfaces may cause the appliance and cart combination to overturn.



Use only a cart or stand recommended by the manufacturer for the specific model of TV. Any mounting of the product should follow the manufacturer's instructions, and should use a mounting accessory recommended by the manufacturer. An appliance and cart combination should be moved with care. Quick stops, excessive force, and uneven surfaces may cause the appliance and cart combination to overturn.

Ventilation

The slots and openings in the cabinet and in the back or bottom are provided for necessary ventilation. To ensure reliable operation of the set, and to protect it from overheating, these slots and openings must never be blocked or covered.

- Never cover the slots and openings with a cloth or other materials.



- Never block the slots and openings by placing the set on a bed, sofa, rug or other similar surface.

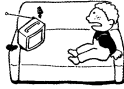

- Never place the set in a confined space, such as a bookcase or built-in cabinet, unless proper ventilation is provided.



- Do not place the set near or over a radiator or heat register, or where it is exposed to direct sunlight.



Power-Cord Protection

Do not allow anything to rest on or roll over the power cord, and do not place the set where the power cord is subject to wear or abuse.



Grounding or Polarization

This set may be equipped with a polarized alternating current line plug (a plug having one blade wider than other). This plug will fit into the power outlet only one way. This is a safety feature. If you are unable to insert the plug fully into the outlet, try reversing the plug. If the plug still fails to fit, contact your electrician to replace your obsolete outlet. Do not defeat the safety purpose of the polarized plug.

Antennas

Outdoor Antenna Grounding

If an outdoor antenna is installed, follow the precautions below. An outdoor antenna system should not be located in the vicinity of overhead power lines or other electric light or power circuits, or where it can come in contact with such power lines or circuits.

WHEN INSTALLING AN OUTDOOR ANTENNA SYSTEM, EXTREME CARE SHOULD BE TAKEN TO KEEP FROM CONTACTING SUCH POWER LINES OR CIRCUITS AS CONTACT WITH THEM IS ALMOST INVARIABLY FATAL.

Be sure the antenna system is grounded so as to provide some protection against voltage surges and built-up static charges. Section 810 of the National Electrical Code (NEC) in USA and Section 54 of the Canadian Electrical Code in Canada provides information with respect to proper grounding of the mast and supporting structure, grounding of the lead-in wire to an antenna discharge unit, size of grounding conductors, location of antenna discharge unit, connection to grounding electrodes, and requirements for the grounding electrode.

Antenna Grounding According to the NEC

Antenna Grounding According to the National Electrical Code, ANSI/NFPA 70.

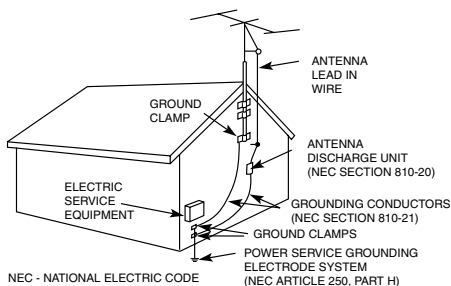

Lightning

For added protection for this television receiver during a lightning storm, or when it is left unattended and unused for long periods of time, unplug it from the wall outlet and disconnect the antenna. This will prevent damage to the receiver due to lightning and power-line surges.

Service

Damage Requiring Service

Unplug the set from the wall outlet and refer servicing to qualified service personnel under the following conditions:

- When the power cord or plug is damaged or frayed.

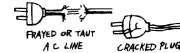

- If liquid has been spilled into the set or objects have fallen into the product.



- If the set has been exposed to rain or water.



- If the set has been subject to excessive shock by being dropped, or the cabinet has been damaged.



- If the set does not operate normally when following the operating instructions. Adjust only those controls that are specified in the operating instructions. Improper adjustment of other controls may result in damage and will often require extensive work by a qualified technician to restore the set to normal operation.



- When the set exhibits a distinct change in performance — this indicates a need for service.

Servicing

Do not attempt to service the set yourself since opening the cabinet may expose you to dangerous voltage or other hazards. Refer all servicing to qualified service personnel.



Replacement Parts

When replacement parts are required, be sure the service technician certifies in writing that he has used replacement parts specified by the manufacturer that have the same characteristics as the original parts. Unauthorized substitutions may result in fire, electric shock, or other hazards.



Safety Check

Upon completion of any service or repairs to the set, ask the service technician to perform routine safety checks (as specified by the manufacturer) to determine that the set is in safe operating condition, and to so certify. When the set reaches the end of its useful life, improper disposal could result in a picture tube implosion. Ask a qualified service technician to dispose of the set.



Contents

Introduction

Introducing the FD Trinitron WEGA [®] Features.....	1
About this Manual.....	2
Batteries for the Remote Control	2
Front Panel Menu Controls	2
Using the Remote Controls	3

Connecting Your TV

TV Rear Panel.....	8
Basic Connections	10
Cable Box Connections	11
Connecting Additional Equipment.....	13

Using Basic Functions

Setting Up the TV Automatically	21
Quick Start to the Menus	22
Using Picture in Picture (PIP) with Remote Y181	24
Using Picture in Picture (PIP) with Remote Y182.....	26
Setups that Affect Your Ability to Use PIP	28
Using Wireless Headphones	29

Using the Menus

How to access menus with Remote Control Y182	33
How to access menus with Remote Control Y181	33
Using the Video Menu	34
Using the Audio Menu	35
Using the Channel Setup Menu.....	37
Using the Parent Menu	39
Using the Timer Menu	45
Using the Setup Menu.....	46
Using the Basic Menu.....	47

Other Information

Programming the Remote Control.....	49
Troubleshooting.....	52
Specifications	55

Index	57
--------------------	----

Introduction

Congratulations on your purchase of the Sony FD Trinitron WEGA®. Before you begin using this manual, please check the model number located on the rear of your TV or on the front cover of this manual.

Introducing the FD Trinitron WEGA® Features

Some of the features you will enjoy include:

- ❑ **FD Trinitron Flat CRT** — Technologically advanced tube delivers a picture with uncompromising accuracy and outstanding image detail.
- ❑ **Y, Pb, Pr Inputs** — A component video input connection for a superior picture quality (480i only).
- ❑ **WOW** — A new audio feature that provides a dramatic presence with a full, deep bass sound. When WOW is enabled, BBE is directly activated to further enhance the audio performance.
- ❑ **TruSurround** — Produces a dynamic three dimensional sound for stereo audio signals.
- ❑ **Parental Control (V-Chip)** — A tool to help parents monitor what their children watch on TV by establishing rating limits.
- ❑ **Wireless Infrared Headphones** — Enjoy the privacy of listening to your favorite programs without disturbing anyone else (for KV-32FV300 and KV-36FV300 only).
- ❑ **ClearEdge VM** — Sharpens picture definition to give objects a sharp, clean edge.
- ❑ **DynaBlack** — Improves contrast and sharpens image detail.
- ❑ **Picture in Picture (PIP)** — Allows you to view two programs simultaneously.
- ❑ **Favorite Channels** — Instant access to your favorite channels with the touch of a button.
- ❑ **Info Banner** — A new, convenient feature that displays the name and the remaining time of the current program viewed, if available.
- ❑ **Universal Remote Control** — Program your remote control to operate your connected cable box, VCR, digital satellite receiver, or DVD player.
- ❑ **Energy Star®** — Meets the Energy Star guidelines for energy efficiency.
- ❑ **Front Panel Controls** — Allows access to the on-screen menus without the use of a remote control.
- ❑ **Front A/V Inputs** — A quick connection for video games, camcorders or stereo/mono equipment.

About this Manual

This manual provides instructions to help you enjoy your new TV. It shows you how to connect to an antenna or cable, cable box, VCR, DVD, satellite receiver, stereo system, or camcorder. Once you're connected, follow the instructions and use the remote control to access the on-screen menus.

Batteries for the Remote Control

Insert two AA (R6) batteries (supplied) into the remote control using the following illustration as a guide.

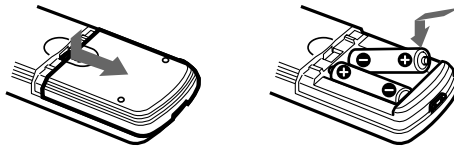



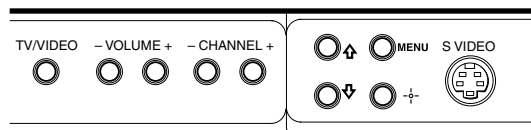

 Under normal conditions, batteries will last up to six months. If the remote control does not operate properly, the batteries might be worn out.

 If you will not be using the remote control for an extended period of time, remove the batteries to avoid possible damage from battery leakage.

Front Panel Menu Controls



The front Audio/Video panel controls allows you to access the menu without the remote control.













- Press  to display the on-screen menu.
- Use the  and  buttons on the front Audio/Video panel instead of your remote control.
- Use the  button on the front Audio/Video panel to navigate , then select an item. The front panel controls also allows you to change your channels CH+/-, adjust the volume VOL +/-, and change video inputs.

 To navigate the menus with your remote control, see "Using the Menus" on page 33.





Using the Remote Controls

Model RM-Y181

For KV-27FV300 model

Button	Description
 1	MUTING Press to turn off the sound. Press again or press  to restore sound.
 2	SYSTEM OFF Press to power off the equipment programmed into the remote control, see "Programming the Remote Control" on page 49.
 3	TV/VCR Press to switch between TV and VCR mode. If you have a non-Sony VCR, you will need to program the remote control to recognize your VCR. For details, see "Programming the Remote Control" on page 49.
 4	ANT (antenna) Press to change from VHF/UHF input to the AUX input, press again to switch back.
 5	PICTURE MODE Press repeatedly to step through the available video picture modes: Vivid, Standard, Movie and Sports. Also available in the Video menu. See "Using the Video Menu" on page 34 for details.
 6	SLEEP Press repeatedly until the TV displays the time in minutes (15, 30, 45, 60, or 90) that you want the TV to remain on before shutting off automatically. Cancel by pressing until Sleep Off appears. While Sleep feature is set, press once to view remaining time.
 7	JUMP Press to jump back and forth between two channels. The TV alternates between the current channel and the last channel that was selected.
 8	TV/SAT Press to switch between the TV and SAT (satellite) inputs when in SAT FUNCTION mode.  Press for a direct selection of Effect settings (Simulated, WOW, TruSurround, Off), when the remote is in TV FUNCTION mode. See "Using the Audio Menu" on page 35 for details.
 9	RESET Press to return to factory settings while in an on-screen menu.
 10	VOL (volume) Press (+) or (-) to adjust the volume.
 11	CODE SET Use to program your remote control to operate connected video equipment. See "Programming the Remote Control" on page 49.

Operating Instructions

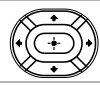
Button	Description
12 POWER buttons	Press to turn on and off the TV and other audio/video equipment you have programmed into the remote control. For instructions, see "Programming the Remote Control" on page 49.
13 FUNCTION buttons	Press to select the equipment (TV, VCR/DVD, SAT/CABLE) that you want to operate with the remote control. The indicator (LED) lights up momentarily when pushed to show which device the remote control is operating.
14 PIP (Picture in Picture)	Operates PIP feature. See "Using Picture in Picture (PIP) with Remote Y181" on page 24.
VCR (operating)	Operates your VCR. The VCR must be programmed into the remote control. For instructions, see "Programming the Remote Control" on page 49.
REC	Press  button and the  button - above left - at the same time to record any programs with your VCR (the remote control must be programmed in order to use REC.)
	Fast-forward.
	Play.
	Stop.
II	Pause. Press again to resume normal playback.
15 TV/VIDEO	Press to cycle through available video inputs.
16 DISPLAY	Press once to display the current time and program status (such as channel number, channel label (if set), video input, and video label). Press again to turn display off.
17 MTS/SAP	Press to cycle through the Multi-channel TV Sound (MTS) options: Stereo, Auto SAP (Second Audio Programming), and Mono.
18 0-9 and ENTER	Press to change channels directly. The channel changes after 2 seconds.
19 GUIDE	Press to display the program guide of your satellite antenna.
20 	Press the arrow buttons to move the cursor in the on-screen menus. Press the center button to select or access an option.
21 MENU	Press to display the on-screen menu. Press again to exit the menu at any time.
22 CH (channel)	Press to change channels. To scan rapidly through the channels, press and hold down the CH+ or CH- button.

 For information on Picture in Picture (PIP) operation buttons, see page 25.





 If you lose your remote control, see page 54.

Model RM-Y182

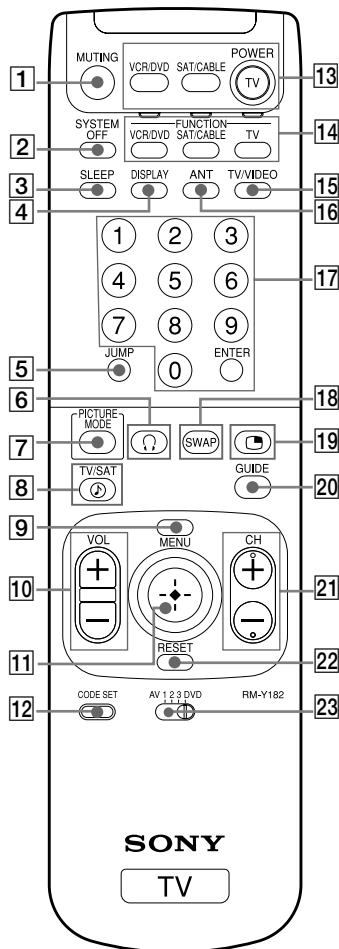

For KV-32FV300, KV-36FV300 models

Outside Panel







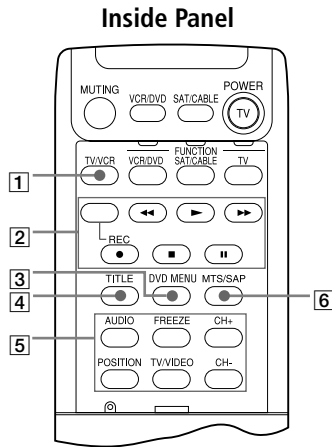

Button	Description
1 MUTING	Press to turn off the sound. Press again or press  to restore the sound.
2 SYSTEM OFF	Press to power off the equipment programmed into the remote control, see "Programming the Remote Control" on page 49.
3 SLEEP	Press repeatedly until the TV displays the time in minutes (15, 30, 45, 60, or 90) that you want the TV to remain on before shutting off automatically. Cancel by pressing until Sleep Off appears. While Sleep feature is set, press once to view remaining time.
4 DISPLAY	Press once to display the current time and program status (such as channel number, channel label (if set), video input, and video label). Press again to turn display off.
5 JUMP	Press to jump back and forth between two channels. The TV alternates between the current channel and the last channel that was selected.
6 	Press to turn the headphones on and off.
7 PICTURE MODE	Press repeatedly to step through the available video picture modes: Vivid, Standard, Movie and Sports. Also available in the Video menu. See "Using the Video Menu" on page 34 for details.
8 TV/SAT	Press to switch between the TV and SAT (satellite) inputs when in SAT FUNCTION mode.
9 	Press for a direct selection of Effect settings (Simulated, WOW, TruSurround, Off), when the remote is in TV FUNCTION mode. See "Using the Audio Menu" on page 35 for details.
10 MENU	Press to display the on-screen menu. Press again to exit the menu at any time.
11 VOL (volume)	Press (+) or (-) to adjust the volume.
12 	Use the joystick to move the on-screen cursor. Press down on the center of the joystick to select the item.
13 CODE SET	Use to program your remote control to operate connected video equipment. See "Programming the Remote Control" on page 49.

Operating Instructions

Button	Description
13 POWER buttons	Press to turn on and off the TV and other audio/video equipment you have programmed into the remote control. For instructions, see "Programming the Remote Control" on page 49.
14 FUNCTION buttons	Press to select the equipment (TV, VCR/DVD, SAT/CABLE) that you want to operate with the remote control. The indicator (LED) lights up momentarily when pushed to show which device the remote control is operating.
15 TV/VIDEO	Press to cycle through available video inputs.
16 ANT (antenna)	Press to change between the VHF/UHF input to the AUX input, press again to switch back.
17 0-9 and ENTER	Press to change channels directly. The channel changes after 2 seconds.
18 	See "Using Picture in Picture (PIP) with Remote Y182" on page 26 for details.
19 	See "Using Picture in Picture (PIP) with Remote Y182" on page 26 for details.
20 GUIDE	Press to display the program guide of your satellite antenna.
21 CH (channel)	Press to change channels. To scan rapidly through the channels, press and hold down the CH+ or CH- button.
22 RESET	Press to return to the factory settings while in an on-screen menu.
23 AV 12 3 DVD 	Use to switch control for connected video equipment. You can program one video source for each switch position. For details, see "Programming the Remote Control" on page 49.

 If you lose your remote control, see page 54.



Button	Description
1 TV/VCR	Press to switch between TV and VCR mode. If you have a non-Sony VCR, you will need to program the remote control to recognize your VCR. For details, see "Programming the Remote Control" on page 49.
2 VCR (operating)	Operates your VCR. The VCR must be programmed into the remote control. For instructions, see "Programming the Remote Control" on page 49.
	Rewind.
REC	Press the  button and the blank button - above, left - at the same time to record any programs with your VCR (the remote control must be programmed in order to use REC.)
	Fast-forward.
	Play.
	Stop.
	Pause. Press again to resume normal playback.
3 DVD MENU	Press to display the DVD's menu.
4 TITLE	Press to display the DVD's Title menu.
5 PIP (Picture in Picture)	Press to operate PIP feature. See "Using Picture in Picture (PIP) with Remote Y182" on page 26.
6 MTS/SAP	Press to cycle through the Multi-channel TV Sound (MTS) options: Stereo, Auto SAP (Second Audio Programming), and Mono.

Connecting Your TV

Read this section before setting up your TV for the first time. This section covers basic connections in addition to any optional equipment you may be connecting.

TV Rear Panel

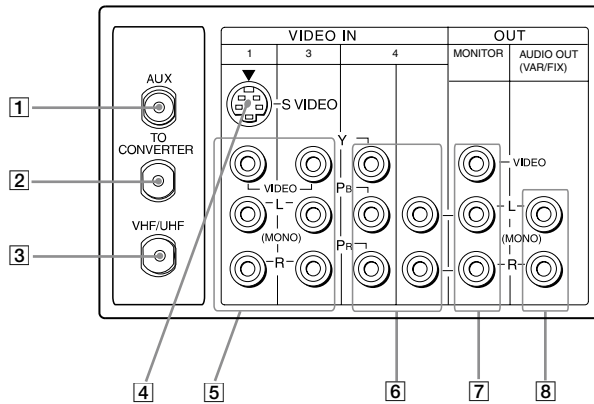

Jack	Description
1 AUX	Allows you to view local and cable channels if your cable provider does not feature local channels. You can switch between local and cable channels easily by pressing ANT on the remote control. Devices connected to the AUX input cannot be viewed in PIP.
2 TO CONVERTER	This is a VHF/UHF out jack that lets you set up your TV to switch between scrambled channels (through a cable box) and normal cable channels (CATV). Use this jack instead of a splitter to get better picture quality when you need to switch between scrambled and unscrambled cable channels.
3 VHF/UHF	Connects to your VHF/UHF antenna or cable.
4 S VIDEO	Connects to the S VIDEO OUT jack on your VCR or other video equipment that has S VIDEO. S VIDEO provides better picture quality than the VHF/UHF jacks or the video input jack. S VIDEO does not provide sound; you still must connect the audio cables.

Jack	Description
5 AUDIO (L/R)/VIDEO	Connects to the AUDIO and VIDEO output jacks on your VCR or other video equipment. A third video input jack (VIDEO 2) is located on the front panel of the TV. These AUDIO/VIDEO input jacks provide better picture quality than the VHF/UHF jack.
6 Y, P_B, P_R/ L, R	Connects to the component video Y, P _B , P _R , and AUDIO L and R jacks on your DVD player or digital set-top box (480i only).
7 MONITOR OUT	Lets you record the program you are watching to a VCR. When two VCRs are connected (see "Connecting Two VCRs for Tape Editing" on page 15), you can use your TV as a monitor for tape-to-tape editing.
8 AUDIO OUT (VAR/FIX) L(MONO)/R	Connects to the AUDIO L and R input jacks on your audio or video equipment. You can listen to your TV's audio through your stereo system.

Basic Connections

TV with Indoor or Outdoor Antenna, or CATV Cable

Depending on the cable available in your home, choose one of the connections below:

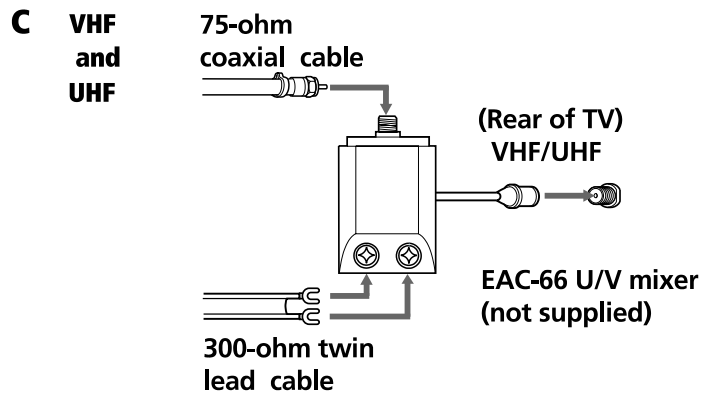
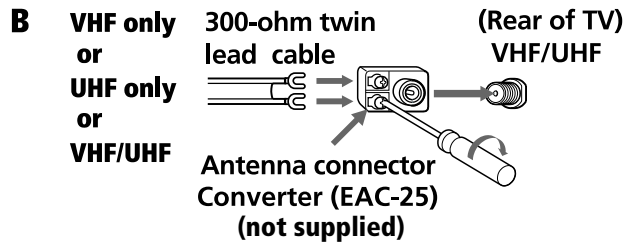
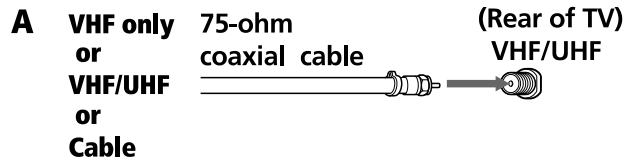

 If you are connecting to an indoor or outdoor antenna, you may need to adjust the orientation of the antenna for best reception.

Cable Box Connections

Some cable TV systems use scrambled or encoded signals that require a cable box to view all channels. If you subscribe to that kind of cable service, use this connection. Scrambled signals coming in to the TV through the cable box cannot be viewed in PIP. If some of your channels are scrambled, consider using the Cable Box and Cable connection.

Cable Box and TV

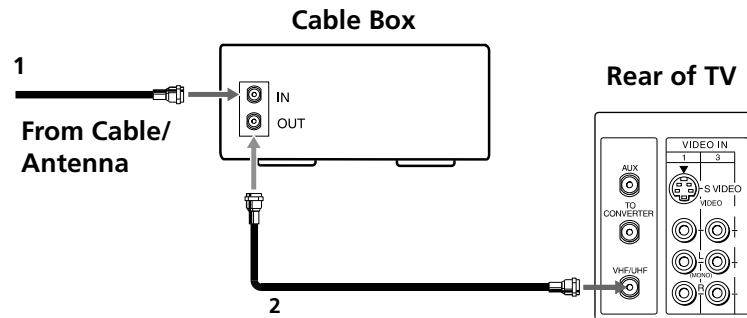

- 1** Connect the coaxial cable from your cable service to the IN jack on your cable box.
- 2** Connect a coaxial cable (not supplied) from the OUT jack on your cable box to the VHF/UHF jack on your TV.

 If you will be controlling all channel selection through your cable box, you should consider using the Channel Fix feature to set your TV to channel 3 or 4 (see page 37).

Cable Box and Cable

Use this connection if you subscribe to a cable system that scrambles some channels (pay channels) but not all of them. This setup allows you to use the remote control to:

- ❑ change channels through your cable box when you are receiving a scrambled signal
- ❑ change channels through your TV

This connection also allows you to use the PIP feature when you are viewing unscrambled channels coming directly into your TV from your cable. Scrambled signals coming through the cable box cannot be viewed in PIP. For more information on the PIP feature, see page 24 or 26.

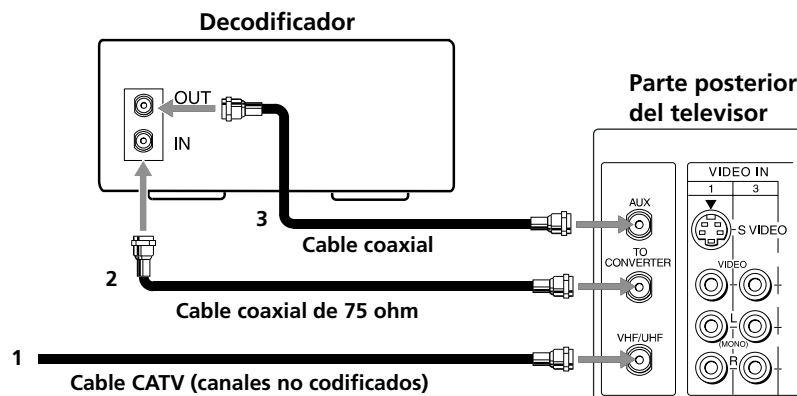

- 1** Connect the coaxial cable from your cable service to the VHF/UHF jack on your TV.
- 2** Using a coaxial cable (not supplied), connect the IN jack on your cable box to the TO CONVERTER jack on your TV.
- 3** Using a coaxial cable (not supplied), connect the OUT jack on your cable box to the AUX jack on your TV.

 Press the ANT button on the remote control to switch between the cable box and direct cable inputs.

 Your Sony remote control can be programmed to operate your cable box (see page 50).

 To use the cable box to change your channels, set your TV to channel 3 or 4. Use the Channel Fix feature to ensure that you don't accidentally switch channels using your TV (see page 37).

Connecting Additional Equipment

Connecting a TV and VCR

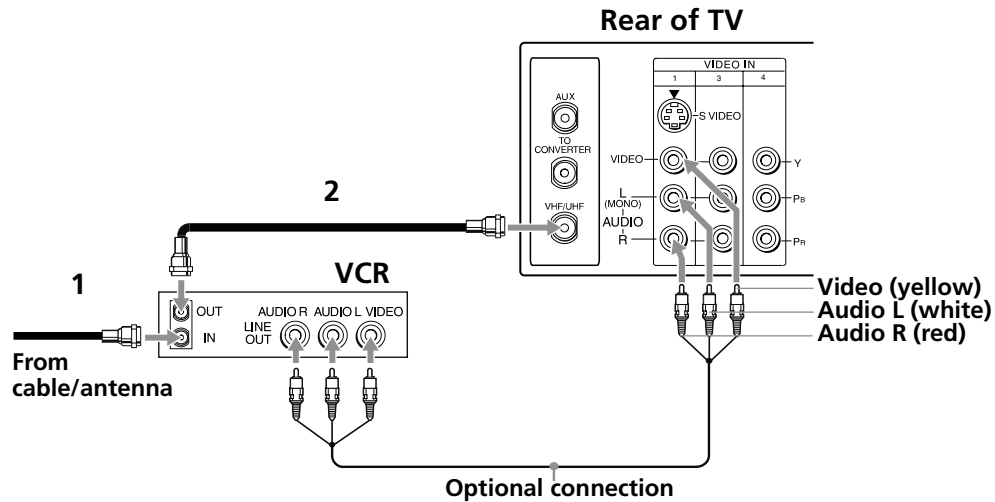

To watch video programs from your VCR, tune your TV to channel 3 or 4 (as set on the rear of your VCR).

- 1** Connect the coaxial cable from your TV antenna or cable service to the IN jack on your VCR.
- 2** Connect a coaxial cable (not supplied) from the OUT jack on your VCR to the VHF/UHF jack on the TV.

Optional connection

If your VCR is equipped with video outputs, you can get better picture quality by connecting audio/video cables (not supplied) from AUDIO and VIDEO OUT on your VCR to AUDIO/VIDEO IN on your TV.

You can use the  button to switch between the VHF/UHF and VIDEO inputs.

For better picture quality, use S VIDEO instead of the yellow audio/video cable. S VIDEO does not provide sound; you still must connect the audio cables.

Connecting a TV, VCR, and Cable Box

Use this connection if you subscribe to a cable system that scrambles some channels (pay channels), but not all of them. This setup allows you to use the remote control to:

- ❑ change channels through your cable box or VCR when you are receiving a scrambled signal
- ❑ change channels through your TV

This connection also allows you to use the PIP feature when you are viewing unscrambled channels coming directly into your TV from your cable. Scrambled signals coming through the cable box cannot be viewed in PIP. For more information on the PIP feature, see page 24 or 26.

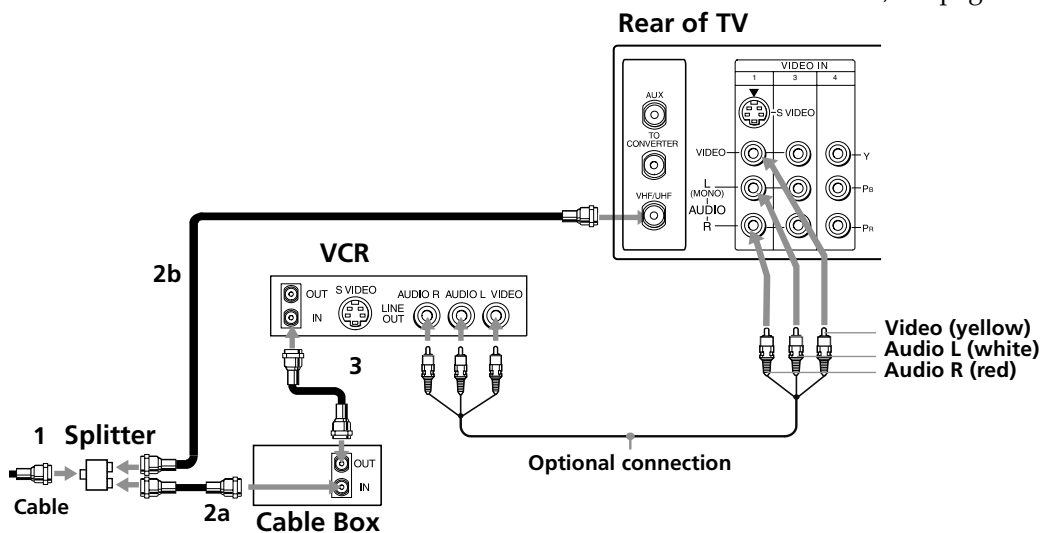

- 1** Connect the single input jack of the splitter to your incoming cable connection.
- 2** Using a coaxial cable (not supplied), connect the two output jacks of the splitter to:
 - a)** the IN jack on your cable box, and
 - b)** the VHF/UHF jack on the TV.
- 3** Using a coaxial cable (not supplied), connect the OUT jack on your cable box to the IN jack on your VCR.

 If you will be controlling all channel selections through your cable box, you should consider using the Channel Fix feature to set your TV to channel 3 or 4 (see page 37).

Optional connection

If your VCR is equipped with video outputs, you can get better picture quality by connecting audio/video cables (not supplied) from AUDIO and VIDEO OUT on your VCR to AUDIO/VIDEO IN on your TV.

 For better picture quality, use S VIDEO instead of the yellow audio/video cable. S VIDEO does not provide sound; you still must connect the audio cables.



 You can use the  button to switch between the VHF/UHF and VIDEO inputs.

Connecting Two VCRs for Tape Editing

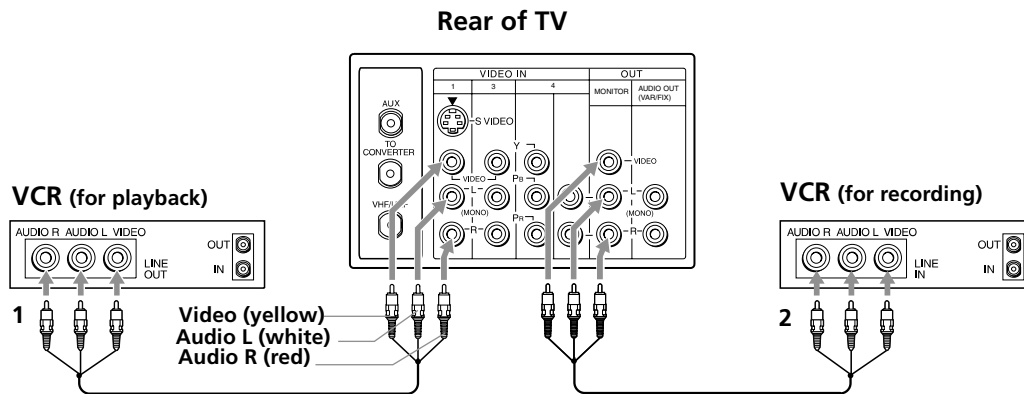
You can connect two VCRs together to edit video tapes. You can also connect both VCRs to your TV to view the program being recorded.



- 1** Using audio/video cables (not supplied), connect AUDIO and VIDEO OUT on your first VCR to AUDIO and VIDEO IN on your TV.
- 2** Using audio/video cables (not supplied), connect AUDIO and VIDEO IN on the second VCR to the MONITOR AUDIO and VIDEO OUT on your TV.

 To perform tape editing, set the TV to the video input intended for playback by pressing .

Connecting a TV and Satellite Receiver

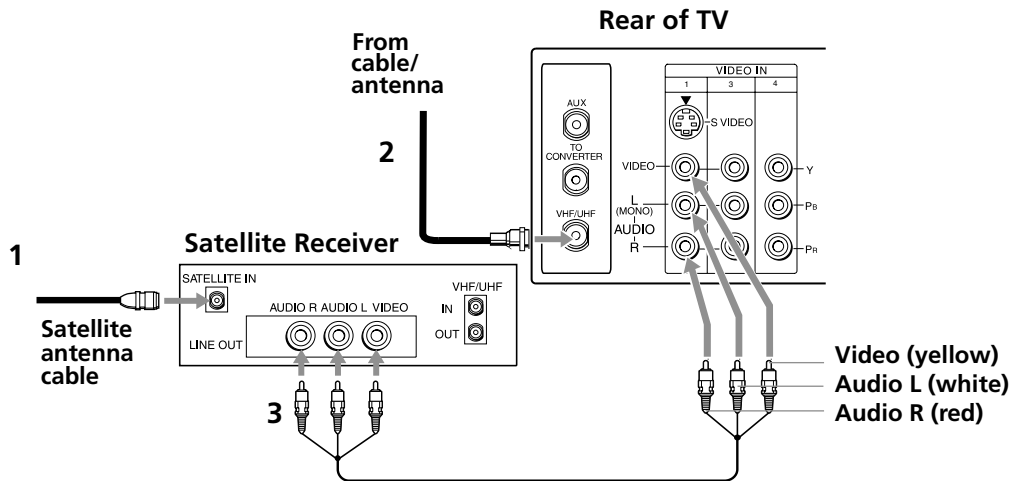

- 1 Connect the cable from your satellite antenna to SATELLITE IN on your satellite receiver.
- 2 Connect the coaxial cable from your cable service or antenna to the VHF/UHF jack on your TV.
- 3 Using audio/video cables (not supplied), connect AUDIO and VIDEO OUT on your satellite receiver to AUDIO and VIDEO IN on your TV.

 You can use the **TV^{VIDEO}** button to switch between the VHF/UHF and VIDEO inputs.

 For better picture quality, use S VIDEO instead of the yellow audio/video cable. S VIDEO does not provide sound; you still must connect the audio cables.

Connecting a TV, Satellite Receiver, and VCR

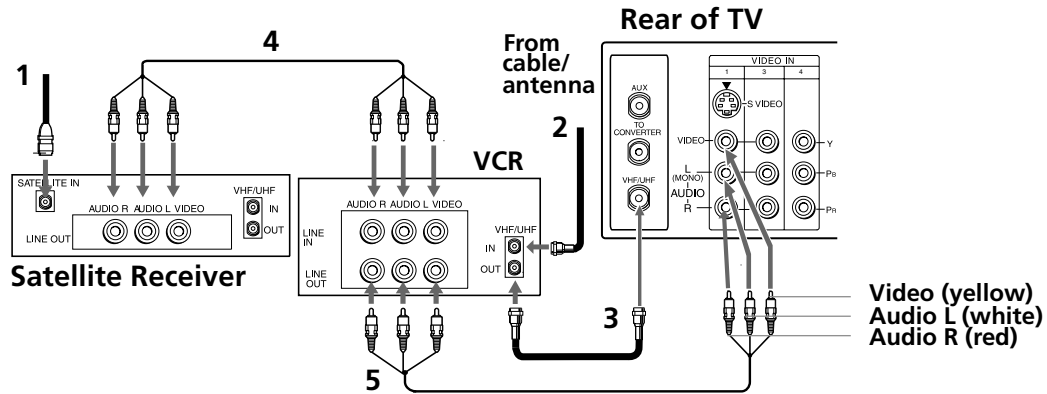

- 1** Connect the coaxial cable from your satellite antenna to SATELLITE IN on the satellite receiver.
- 2** Connect the coaxial cable from your cable service or antenna to the IN jack on your VCR.
- 3** Using a coaxial cable (not supplied), connect the OUT jack on your VCR to the VHF/UHF jack on your TV.
- 4** Using audio/video cables (not supplied), connect AUDIO and VIDEO OUT on your satellite receiver to AUDIO and VIDEO IN on your VCR.
- 5** Using audio/video cables (not supplied), connect AUDIO and VIDEO OUT on your VCR to AUDIO and VIDEO IN on your TV.

 To view from the satellite receiver or VCR, select the video input to which your satellite receiver or VCR is connected by pressing **TV/VIDEO** on the remote control.

Connecting a DVD Player

Using audio/video cables (not supplied), connect AUDIO and VIDEO OUT on your DVD player to AUDIO and VIDEO IN on your TV.

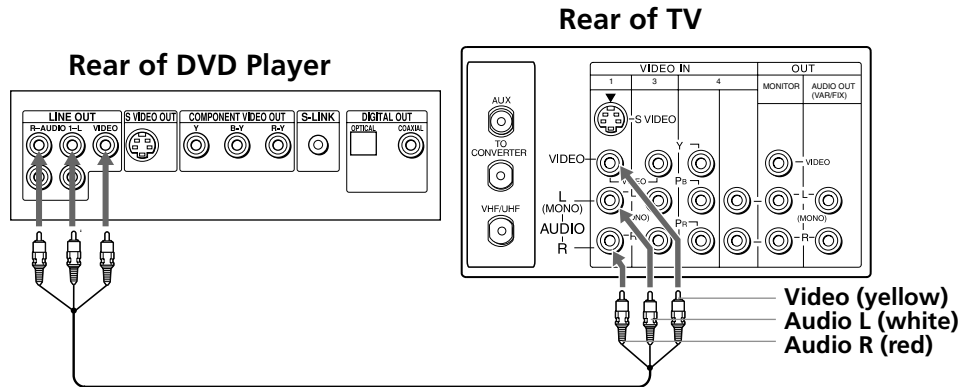

For better picture quality, use S VIDEO instead of the yellow Audio/Video cable. S VIDEO does not provide sound; you still must connect the audio cables.

Optional connection

If your DVD player is equipped with component video outputs (Y, P_B, P_R), you can improve the picture quality by using component video cables (480i only).

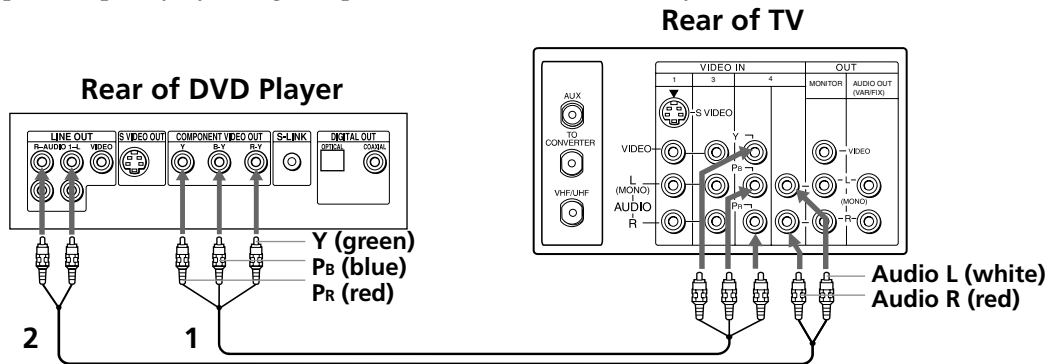

- 1 Using component video cables (not supplied), connect the Y, P_B, P_R OUT on your DVD player to Y, P_B, P_R IN on your TV.
- 2 Connect AUDIO OUT on your DVD player to AUDIO IN on your TV.

The Y, P_B, P_R outputs on your DVD player are sometimes labeled Y, C_B, and C_R or Y, B-Y, and R-Y. If so, connect the cables to like colors.

Connecting a Camcorder

Using audio/video cables (not supplied), connect AUDIO and VIDEO OUT on your camcorder to AUDIO and VIDEO IN on your TV.

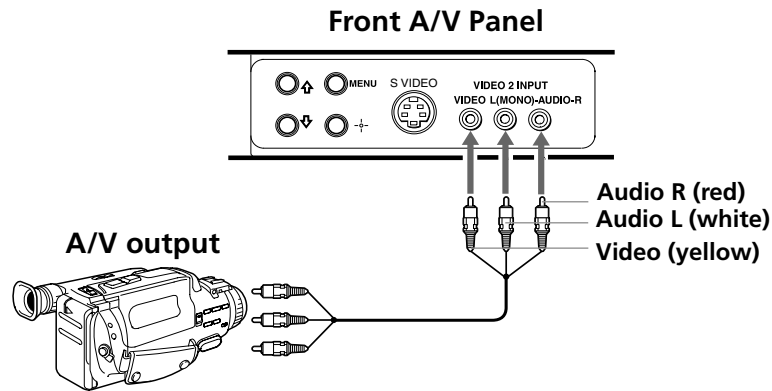

If the camcorder has an S VIDEO jack, you can use an S VIDEO cable to improve picture quality; replace the yellow video cable of the combination Audio/Video cable with the S VIDEO cable. You will still need audio cables for sound.

Connecting an Audio System

Using audio cables (not supplied), connect AUDIO OUT on your TV to one of the unused line inputs (e.g. TV, AUX, TAPE2) on your stereo.

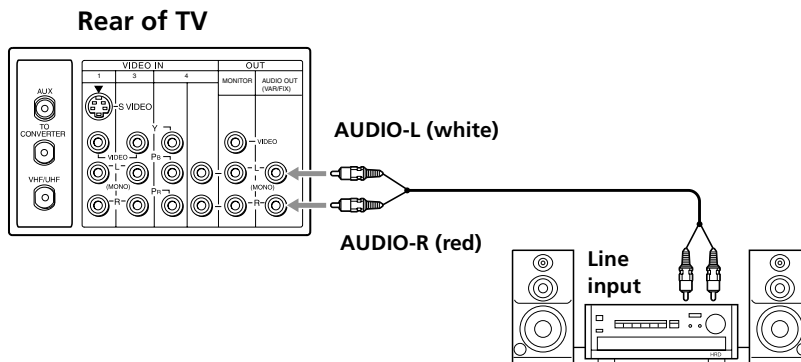

Set your stereo to the selected line input. See "Using the Audio Menu" on page 35 for additional audio setup instructions.

Using Basic Functions



Setting Up the TV Automatically

After you have finished connecting your TV, you can perform Auto Program to set up your channels. When Auto Programming, the TV will automatically search for available channels and program receivable channels.

 The direction in this manual will refer to the remote control that incorporates a joystick (RM-Y182). See "Using the Remote Control" on page 3 for further details on this remote.

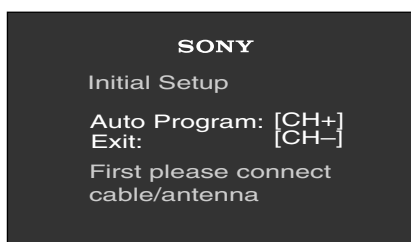



- 1 Press  to turn on the TV. The Initial Setup screen appears.





- 2 Press  on the remote control or on the TV front panel to perform Auto Program, or press  to exit.

 The Initial Setup screen appears each time you turn on the TV until you perform Auto Program.

To perform Auto Program again





- 1 Press .
- 2 Use the joystick to highlight Channel Setup Menu.
- 3 Use the joystick to scroll down to highlight Cable. Press  to select.
- 4 Use the joystick to scroll up and down select On or Off according to how you connected your TV. Press .
- 5 Use the joystick to highlight Auto Program. Press  to search for channels.
- 6 After performing Auto Program, press  to exit.

To reset the TV to factory settings

- 1 Turn the TV on.
- 2 Hold down  on the remote control.
- 3 Press and release the POWER button on the TV front panel. (The TV will turn itself off, then back on.)
- 4 Release .

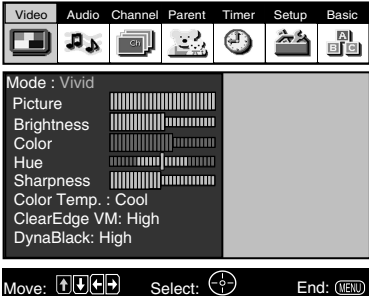
Quick Start to the Menus

The following settings are available in your on-screen menus. For more details on how to use the menus, see "Using the Menus" on page 33.

Menu	Allows you to
	Make adjustments to your picture settings.
	Change your audio settings.
	Customize your channel settings.
	Set rating limits on your TV based on program rating or content.

Menu

Allows you to

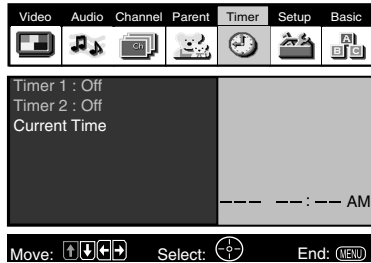

Set the clock on your TV and program scheduled viewing using Timer 1 and Timer 2.

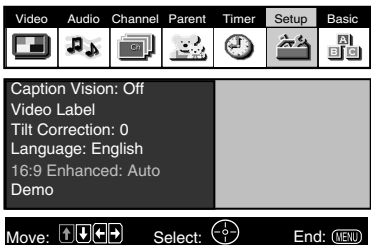

Select closed captioning options, label video inputs, adjust tilt correction, enhance your picture resolution for your DVD (16:9 Enhanced), select menu language, or run a demo of the menus.

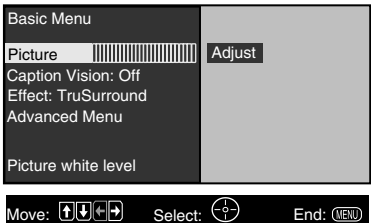
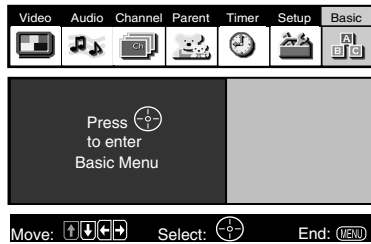

Set the menus to display a simplified menu of most commonly-used menu settings.

Using Picture in Picture (PIP) with Remote Y181

The Picture-in-Picture (PIP) feature allows you to view two programs simultaneously, one in the full size “main” picture and one in a small “window” picture.

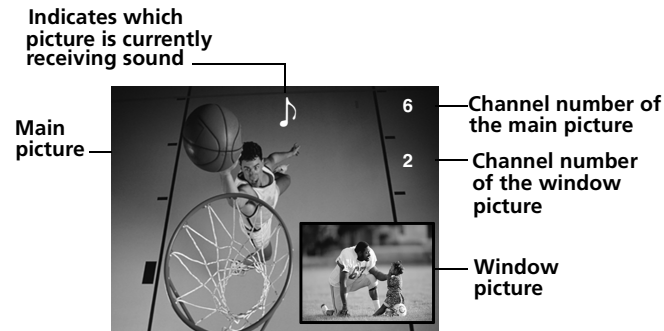

Displaying Picture in Picture



To use PIP

- 1 Press the TV button in the FUNCTION bar to control PIP with the yellow-labeled buttons. Tune your TV to a channel which you know is currently airing programming.
- 2 Press the  button to display the window picture.
- 3 Use the PIP (yellow) CH +/- buttons to change the channel in the PIP window picture.

To check your PIP









- 1 Press the TV button in the FUNCTION bar to control PIP with the yellow-labeled buttons. Tune your TV to a channel which you know is currently airing programming.
- 2 Press the  to turn PIP on. Press , the channel from the main window should now appear in the window picture.
- 3 Select the same channel in the main picture (use the CH +/- buttons on the bottom of your remote control). You should now have the same program playing in both windows.
- 4 Use the PIP (yellow) CH +/- buttons to change the channel in the PIP window picture.
- 5 Press the  PIP (yellow) button to switch the PIP window to other video inputs for other equipment that is connected to any of the VIDEO IN jacks of your TV. You should see a different picture in your PIP window for each piece of connected video equipment. Make sure the connected equipment is turned on and working when you perform this test.
- 6 If the PIP feature does not work properly with the TV or the connected video equipment, refer to the troubleshooting section beginning on page 52.

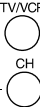

If you're having problems with PIP, refer to "Setups that Affect Your Ability to Use PIP" (page 28) or see Troubleshooting section (page 52) for possible solutions.

PIP Functions buttons

For KV-27FV300 model

Yellow labeled PIP button	Description
	Press to turn the PIP feature on and off. Press repeatedly to change the window size (1/9, 1/16, Off).
	Press to cycle through the available video equipment you have connected to the TV (in the PIP window picture).
	Press to alternate sound between the main picture and the PIP window picture. The sound symbol  appears for three seconds, indicating whether you are hearing the sound from the main or PIP window picture.
	Press to change the channel in the PIP window picture. To change the channel in the main window, use the main CH+/- buttons at the bottom of the remote control.
	Press to move the location of the window picture to any of the four corners of the screen.
	Press to freeze the window picture. Press again to restore the picture. The main window continues to play as usual.
	Press to switch the main picture with the PIP window picture. Press again to switch back.



For more information about your remote control, see "Using the Remote Controls" on page 3.

To change channels/programs in the PIP window

- Use the yellow PIP CH+/- button to scroll through TV channels.
- Use the yellow TV/VIDEO button to cycle through your other video equipment connected to the TV, such as your VCR, DVD player, or satellite receiver.

Using Picture in Picture (PIP) with Remote Y182

The Picture-in-Picture (PIP) feature allows you to view two programs simultaneously, one in the full size “main” picture and one in a small “window” picture.

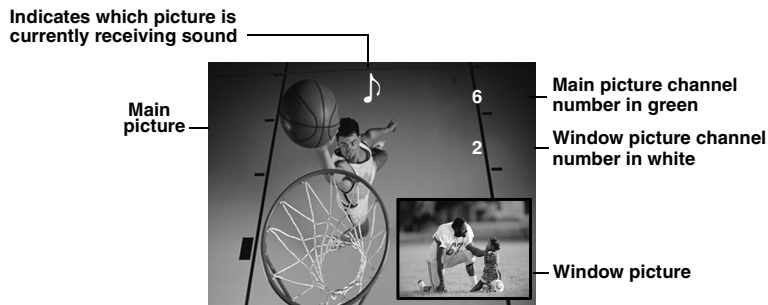

Displaying Picture in Picture



To use PIP

- 1 Press the TV button in the FUNCTION bar to control PIP with the yellow-labeled buttons. Tune your TV to a channel which you know is currently airing programming.
- 2 Press the  button to display the window picture.
- 3 Use the PIP (yellow) CH+/- buttons to change the channel in the PIP window picture.

To check your PIP





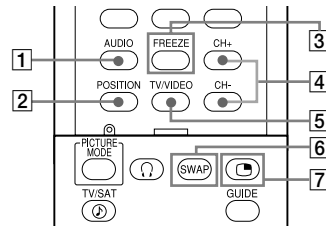

- 1 Press the TV button in the FUNCTION bar to control PIP with the yellow-labeled buttons. Tune your TV to a channel which you know is currently airing programming.
- 2 Press the  to turn PIP on. Press , the channel from the main window should now appear in the window picture.
- 3 Select the same channel in the main picture (use the CH+/- buttons on the bottom of your remote control). You should now have the same program playing in both windows.
- 4 Use the PIP (yellow) CH+/- buttons to change the channel in the PIP window picture.
- 5 Press the  PIP (yellow) button to switch the PIP window to other video inputs for other equipment that is connected to any of the VIDEO IN jacks of your TV. You should see a different picture in your PIP window for each piece of connected video equipment. Make sure the connected equipment is turned on and working when you perform this test.
- 6 If the PIP feature does not work properly with the TV or the connected video equipment, refer to the troubleshooting section beginning on page 52.

 If you're having problems with PIP, refer to "Setups that Affect Your Ability to Use PIP" (page 28) or see Troubleshooting section (page 52) for possible solutions.

PIP Functions buttons

For KV-32FV300, KV-36FV300 model



Yellow-labeled PIP Button	Description
1 	Press to alternate sound between the main picture and the PIP window picture. The sound symbol (♫) appears for 3 seconds, indicating whether you are hearing sound from the main picture or the PIP window picture.
2 	Press to move the location of the window picture to any of the four corners of the screen.
3 	Press to freeze the window picture. Press again to restore the window picture. The main window continues to play as usual.
4 	Press to change the channel in the PIP window picture. To change the channel in the main window, use the main CH+/- buttons at the bottom of the remote control.
5 	Press to cycle through the available video equipment you have connected to the TV (in the PIP window picture).
6 	Press to switch the main picture with the PIP window picture. Press again to switch back.
7 	Press to turn the PIP feature on and off. Press repeatedly to change the window size (1/9, 1/16, Off).

 For more information about your remote control, see "Using the Remote Controls" on page 3.

To change channels/programs in the PIP window

- Use the yellow PIP CH+/- button to scroll through TV channels.
- Use the yellow TV/VIDEO button to cycle through your other video equipment connected to the TV, such as your VCR, DVD player, or satellite receiver.

Setups that Affect Your Ability to Use PIP

- ❑ Any video equipment you have connected to the AUX input cannot be viewed in the PIP window.
- ❑ If you are viewing all channels through a cable box, the PIP feature will not work. The cable box only unscrambles one signal at a time, so the window picture will be the same as the main picture.
- ❑ You can use PIP to see pictures from different sources on your TV. For example, you can have a regular (CATV) channel and the output from a VCR, DVD player or satellite receiver on screen at the same time using PIP. To do this:
 - 1** Connect the CATV cable to the VHF/UHF input on the back of the TV.
 - 2** Connect the peripheral (VCR, DVD player or satellite receiver) to any of the VIDEO IN inputs on the the back of the TV.
 - 3** Tune to one image in the main picture.
 - 4** Tune to a second image in the PIP window.You can then SWAP the images on the TV screen.

 You cannot use a signal from the AUX input with PIP.

Using Wireless Headphones

 Wireless headphones are included and can be used only with Sony TV models KV-32FV300 and KV36FV300.

Installing the Battery

Install the supplied size AA (R6) battery into the headphones.

- 1 Open the battery compartment lid by pressing and sliding the lid as illustrated.

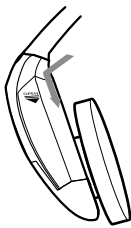

- 2 Insert the battery into the compartment with the positive side up and then close the lid.

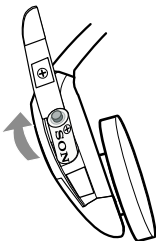



When used continuously, the battery lasts:

- up to 40 hours with an alkaline battery
- up to 20 hours with a manganese battery

Replace the battery with a new one when the sound becomes weak.

Using the Headphones

- 1 Press . (The  icon and channel number display.)



- 2 Place the headphones securely onto your head.

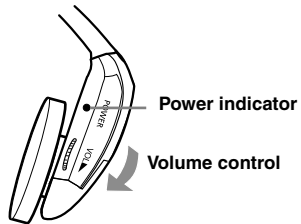

To listen to sound only from wireless headphones

- Turn down the TV speaker level, or press MUTING on the remote control.

To turn off headphones

- Put down the headphones and press .

To ensure optimal sound reception with headphones

- Be sure that the infrared transmitter on the TV and the infrared sensors on the headphones have a clear (unobstructed) line of sight to one another.

To protect the TV's infrared transmitter from possible damage

- Press  to turn off the headphone feature when the headphones are not in use.

To protect your hearing from sudden or prolonged excessive volume

- Set the headphone volume just high enough to hear comfortably.

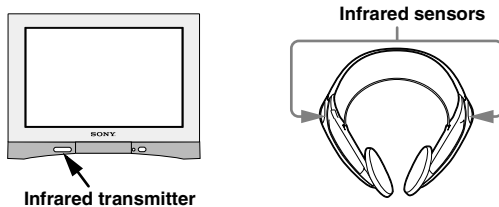

For optimal sound quality, be sure that the infrared transmitter on the TV and the infrared sensors on the headphones are not obstructed and can "see" one another.



Listening to Sound from Main and PIP Window Pictures

To use your headphones to listen to the sound from the main or window picture (when using PIP), select the audio source.

- 1 If PIP is not displayed, press  to display a PIP window.





- 2 Press .

The  icon and channel number appear for about three seconds. The  is level with the channel number of the main picture.



Main picture audio

Press  again to switch the audio to the PIP window.
The  icon changes, dropping down to the level of the PIP channel.



Window picture audio

- 3 When you are finished using the headphones, press  to turn them off.





Headphones off

 When you exit PIP, the sound will return to the main picture. SAP (Second Audio Program) are not available in the PIP Window. The audio to the headphones automatically turns off when you turn off the TV.



Using the Menus

This section shows the options available for setting up and adjusting the TV.



Depending on the model of television that you have purchased, your remote control will have either a joystick (RM-Y182), or directional buttons (↑ ↓ ← →) and a  button (RM-Y181).



 The directions in this manual will refer to the remote control that incorporates a joystick (RM-Y182). See “Using the Remote Control” on page 3 for further details of this remote.

How to access menus with Remote Control Y182

- 1 Press  to display the on-screen menu.
- 2 Use the joystick to highlight the desired menu icon. Press  to select it.
- 3 Use the joystick to scroll up and down through the features.
- 4 Follow the instructions on the screen.
- 5 See the specific menu page for instructions on moving through the menu.
- 6 Press  to exit the menu.

How to access menus with Remote Control Y181

- 1 Press  to display the on-screen menu.
- 2 Use the ← or → buttons to highlight the desired menu icon. Press  to select it.
- 3 Use the ↑ or ↓ buttons to scroll up and down through the features.
- 4 Follow the instructions on the screen.
- 5 See the specific menu page for instructions on moving through the menu.
- 6 Press  to exit the menu.

 Depending on the model, press  once to display the on-screen menu, and press again to return to normal viewing. If no buttons are pressed, the menu closes automatically after about 90 seconds.

Using the Video Menu

To access the Video menu, refer to the following steps using the joystick of your remote control:

To Display



To Select



Press joystick  to highlight an option then press .

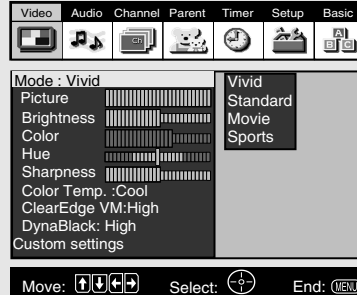



Mode

Customized picture viewing

Use the joystick to scroll up or down to select from one of the following options, then press .

- Vivid:** Select for enhanced picture contrast and sharpness.
- Standard:** Select for a standard picture.
- Movie:** Select for a finely detailed picture.
- Sports:** Select for a bright picture.

 Press  button on the remote control for direct access to the Picture Modes (Vivid, Standard, Movie, Sports).

Picture Controls

- Picture:** Press the joystick left to decrease the contrast.
Press the joystick right to increase the contrast.
- Brightness:** Press the joystick left to darken the picture.
Press the joystick right to brighten the picture.
- Color:** Press the joystick left to decrease the color saturation.
Press the joystick right to increase the color saturation.
- Hue:** Press the joystick left to increase the red tones.
Press the joystick right to increase the green tones.
- Sharpness:** Press the joystick left to soften the picture.
Press the joystick right to sharpen the picture.

Color Temp.

White tint adjustment

Use the joystick to scroll up or down to select from one of the following options, then press .

- Cool:** Gives white colors a blue tint.
- Neutral:** Gives white colors a neutral tint.
- Warm:** Gives white colors a red tint.

ClearEdge VM

Sharpens picture definition to give objects a sharp, clean edge. Use the joystick to scroll up or down to select from one of the following options: **Off**, **High**, **Low**, then press .

DynaBlack

Improves contrast and sharpens image detail. Use the joystick to scroll up or down to select from one of the following options: **Off**, **High**, **Low**, then press .

Using the Audio Menu

To access the Audio menu, refer to the following steps:

To Display





To Highlight







To Select

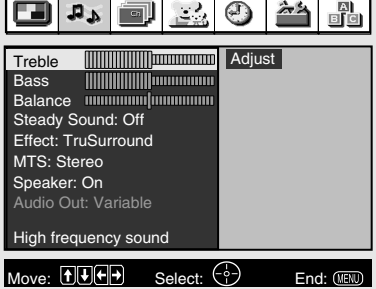

Press joystick  to highlight an option then press .





Treble	Press the joystick left to decrease higher pitched sound. Press the joystick right to increase higher pitched sound.
Bass	Press the joystick left to decrease lower pitched sound. Press the joystick right to increase lower pitched sound.
Balance	Press the joystick left to emphasize the left speaker. Press the joystick right to emphasize the right speaker.
Steady Sound <i>Stabilizes volume</i>	Use the joystick to scroll up or down to select from one of the following options, then press  to select it. On: Select to stabilize the volume when changing channels. Off: Select to turn Steady Sound Off.
Effect	Use the joystick to scroll up or down to select from one of the following options, then press  to select it. Simulated: Simulates theater quality sound for mono programs. WOW: Provides a dramatic presence with a full, deep bass sound. When WOW is enabled, BBE is directly activated to further enhance the audio performance. TruSurround: Produces a dynamic three dimensional sound for stereo audio signals. Off: Normal stereo or mono reception.

 Press  for direct selection of Effect settings (Simulated, WOW, TruSurround, Off).

Operating Instructions

MTS <i>Multi-Channel TV Sound</i>	Use the joystick to scroll up or down to select from one of the following options, then press + to select it. Stereo: Select when viewing a broadcast in stereo. Auto SAP: Select to have the TV automatically switch to a Second Audio Program (SAP) when a signal is received. Mono: Select to reduce noise in areas of poor reception.
---	--

 Press  button on the remote control for direct access to the MTS settings (Stereo, Auto SAP, Mono).

Speaker <i>Custom selection of audio output source</i>	Use the joystick to scroll up or down to select from one of the following options, then press + to select it. On: Select to listen to the sound from the TV speakers with or without a separate stereo system. Off: Select to turn off the TV speakers and listen to the TV's sound only through external audio system speakers.
--	---

Audio Out <i>Use to control the TV's volume through a stereo</i>	Use the joystick to scroll up or down to select from one of the following options, then press + to select it. Audio Out settings can only be set when speakers are set to Off. Variable: Adjust the volume through your TV. Fixed: Adjust the TV volume through a connected stereo.
--	---

 Audio Out settings can only be set when Speaker is set to Off.



 If your TV is set to Auto SAP, some programs may be muted or distorted. If your TV does not output sound, change your Audio MTS setting to Stereo or Mono.

Using the Channel Setup Menu

To access the Channel Setup menu, refer to the following steps:

To Display **To Highlight**  **To Select**





Press joystick  to highlight an option then press .



Favorite Channels

Quick access to favorite channels

Press  to open the Favorite Channels menu:

- 1 Use the joystick to scroll up or down to select the position (1-8) where you want to set a favorite channel, then press .
- 2 Use the joystick to scroll through the channels until you find the channel you want to add to your favorite channels.
- 3 Press  to select it, that will change your TV automatically to the selected channel.
- 4 Press the joystick left to return to the channel setup menu or press  to exit.

 To use Favorite Channels: Exit all menus and press . Press  or  to move the cursor to the desired channel number and press .

Cable

Use the joystick to scroll up or down to select from one of the following options, then press .

- On:** Select if you are receiving cable channels with a CATV cable.
Off: Select if you are using a TV antenna.

 After changing your cable settings, you will need to perform Auto Program.

Channel Fix

Use the joystick to scroll up or down to select from one of the following options, then press .

- 2-6:** Select when you want to control all channel selection through a cable box or VCR. Select the appropriate channel (usually 3 or 4) and use the cable box's or VCR's remote control for channel selection.
- Video 1:** Select from available video inputs when you have connected video equipment (e.g. satellite receiver) and you want your TV fixed to it.
- AUX 2-6:** Use this setting instead of the **2-6** if you want to change channels using a cable box, VCR or satellite receiver and you've connected it to the AUX input.
- Off:** Channel Fix is not set.

Operating Instructions

Auto Program	Perform Auto Program whenever setting up your TV. Auto program will search for available channels and program receivable channels.
Channel Skip/Add	Use this feature after you run Auto Program to skip unwanted channels or add new ones. Press to open Channel Skip/Add menu: <ol style="list-style-type: none">1 Use the joystick to scroll up and down to select the position of the desired channel, then press .2 Use the joystick to scroll up and down to select Skip/Add, then press .3 Press the joystick left to return to the channel setup menu or press to exit.

Pressing CH+ or CH- will skip over channels that have been skipped. You can still use the buttons to directly tune to skipped channels.

Channel Label <i>Label up to 40 channels with their call letters</i>	Press to open the Channel Label menu: <ol style="list-style-type: none">1 Press , then use the joystick to scroll through the channels until you reach the desired channel number.2 Press to activate the channel.3 Scroll down to highlight "Label", then press . Use the joystick to scroll up or down to display the first call letter or number of the caption. Press to select. Repeat this process until you finish selecting all the call letters.4 When finished, press to activate.5 Press the joystick left to return to the channel setup menu or press to exit.
--	--

You cannot use Favorite Channels, Cable, Channel Skip/Add, and Channel Label when Channel Fix is set.

Using the Parent Menu

To access the Parent menu, refer to the following steps:

To Display **To Highlight**  **To Select**

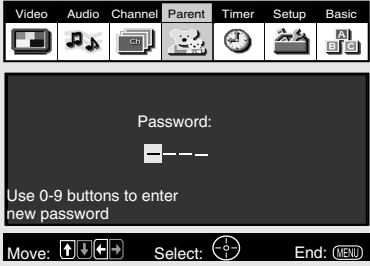



The Parental Control feature is designed to help parents monitor what their children watch on television.

To use the Parent Menu

In Parent menu, you will be asked to set a 4-digit password for any further access into Parent menu.

- 1** Use the ①-⑨ buttons to enter a 4-digit password.
- 2** Confirm your password by entering it again.

 Keep this manual in a safe place. You need your password for any future access to the Parental Control menu. If you forget your password, see page 54.

Once your password is set correctly, the Parent menu appears.

Parental Control

Setting the Rating

You can change the Rating by selecting one of the Parental Lock options.



- 1 Use the joystick to highlight Parental Lock, press \odot .

If you are not familiar with Parental Guideline rating system, use one of the following preset categories to simplify the rating selection: Child, Youth, Young Adult.

- 2 Use the joystick to scroll up or down to select the desired rating and press \odot .

Rating	TV will allow a maximum rating of
Child	TV-Y, TV-G, G (U.S.), G, C (Canada)
Youth	TV-PG, PG (U.S.), 8 ans + (Canada)
Young Adult	TV-14, PG-13 (U.S.), 14+ (Canada)
Custom	Select to set more restrictive ratings (see next section)
Off	No rating limit

Changing your Password

- 1 Use the joystick to scroll up or down to move the cursor to Change Password and press \odot .
- 2 Follow steps 1 and 2 for “Using the Parent Menu” on page 39.



Select a Country

Select U.S.A. to use US ratings (see pages 42-43) or select Canada to use Canadian ratings (see page 44). If you select a Country (U.S.A. or Canada) that is not where you live, the rating you select will not be activated.

- 1 Use the joystick to highlight Parental Lock, press \odot .
- 2 Use the joystick to scroll up or down to select the desired country and press \odot .

Information for Parents

To view a program that exceeds the TV rating

- Press , then use the - buttons to enter your password.

 Entering your password to view a blocked program will temporarily turn Lock to Off. To reactivate your Lock settings, turn the TV off then back on; the TV will return to the settings that you have selected.

Using the Custom Menu

Follow the instructions on the screen to make your custom settings. Select the country desired for your TV's rating limit. See page 42 for U.S. models and page 44 for Canadian models for more information.

 Once you have blocked a rating or content, all higher ratings or content will be automatically blocked.

United States: Selecting Custom Rating Options

For the United States, the Custom Rating Menu includes the following options: Movie Rating, TV Rating and Unrated. (For Canada, see page page 44.)

Movie Rating

This system defines the rating levels of movies shown in theaters and on prime cable channels.

Rating	Defined as
G	General audience
PG	Parental Guidance suggested
PG-13	Parents strongly cautioned
R	Restricted
NC-17	No one 17 and under admitted
X	Adult audience only



TV Rating

The TV rating is divided into two groups: age-based and content-based.

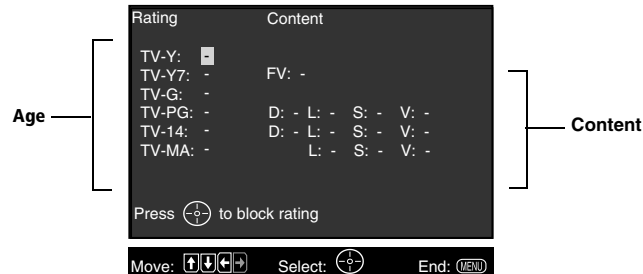

Age	Defined as
TV-Y	All children
TV-Y7	Directed to older children
TV-G	General audience
TV-PG	Parental Guidance suggested
TV-14	Parents strongly cautioned
TV-MA	Mature Audience only

Content	Defined as
FV	Fantasy Violence
D	Suggestive dialogue
L	Strong language
S	Sexual situations
V	Violence

The content ratings will increase depending on the level of the age-based rating. For example, a program with a TV-PG V (Violence) rating may contain moderate violence, while a TV-14 V (Violence) rating may contain intense violence.

Unrated

You have the option of blocking TV programs or movies that are not rated.

Allow	Allows all unrated programs
Block	Blocks all unrated programs

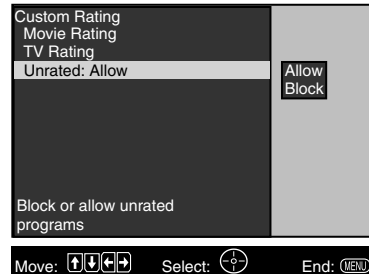

 If you choose to block unrated TV programs, please be aware that the following programs may be blocked: emergency broadcasts, political programs, sports, news, public service announcements, religious programs and weather.

Canada: Selecting Custom Rating Options

For Canada, the Custom Rating Menu includes the following options: English Rating, French Rating and U.S.A. Rating.

English Rating

These ratings are for Canadian programs that are broadcast in English.

Rating	Defined as
C	Children
C8+	Children 8 years and older
G	General programming
PG	Parental Guidance
14+	Viewers 14 and older
18+	Adult programming

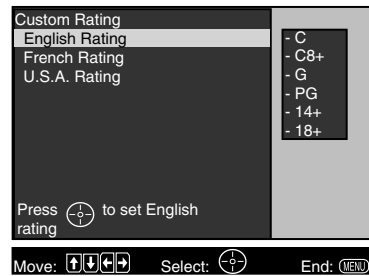

French Rating

These ratings are for Canadian programs that are broadcast in French.

Rating	Defined as
G	General
8 ans+	Not recommended for younger children
13 ans+	Not recommended for children under age 13
16 ans+	Not recommended for ages under 16
18 ans+	This program is restricted to adults



U.S.A. Rating



For programs from the United States, please see “TV Rating” on page 42.

Using the Timer Menu

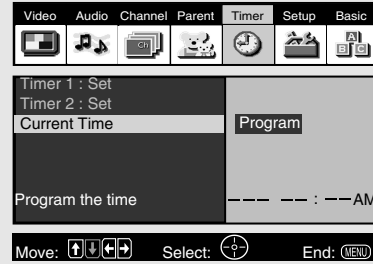
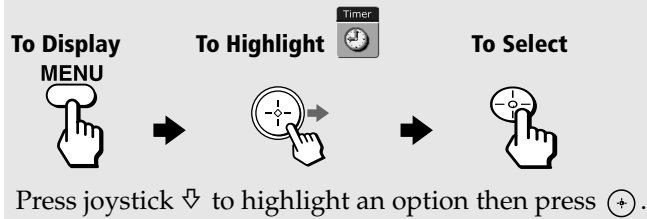
To access the Timer menu, refer to the following steps:





Current Time Set your TV to the current day and time.

- 1 Use the joystick to scroll up or down to enter the correct day and time, then press .
- 2 Press  to return Timer menu or press  to exit the menu.

 You must set the Current Time before you can use Timer 1 or Timer 2.

Timer 1 and Timer 2 Use the timers to program your TV to turn on and off by day, time, duration and channel. The timers duration is maximum of 6 hours. When the channel is fixed, it is not necessary to set the channel. Press  to program Timer 1 or Timer 2.

Scheduled viewing

- 1 Use the joystick to highlight to select Timer 1 or Timer 2, then press .
- 2 Use the joystick to enter the desired day, start time, duration, and channel, then press . The timer status should be On when the Timer has been set, and the Timer light on the front panel of the TV should be turned on.
- 3 Press  to exit the menu.



 Select Off to turn off the Timer (your previous settings will be saved).

 When you perform Auto Program, Timer 1 and Timer 2 settings will be cleared. Also, in the event of any loss of power, Current Time, Timer 1 and Timer 2 settings will be cleared.

Using the Setup Menu

To access the Setup menu, refer to the following steps:



Press joystick  to highlight an option then press .

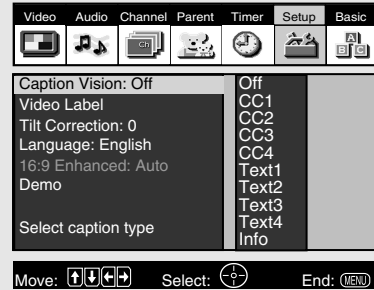



Caption Vision
Closed-Captioning

Allows you to select from three closed caption modes (for programs that are broadcast with closed captioning).
Use the joystick to scroll up or down to select from one of the following options, then press  to select it.

- CC1, 2, 3, 4:** Displays printed dialogue and sound effects of a program.
- Text1, 2, 3, 4:** Displays network/station information.
- Info:** Displays the name of the current program and its remaining time, if available.
- Off:** Caption Vision is not activated.

Video Label
Label connected equipment

Allows you to identify the audio/video components connected to the TV: VCR, DVD, etc. When you press TV/VIDEO to switch inputs, the Video Label will display on-screen. Press  to open the Video Label menu:

- 1 Use the joystick to scroll up or down to select the video input you want to label and press .
- 2 Use the joystick to choose a label and press .

 If you select "Skip", your TV skips this connection when you press the TV/VIDEO button.

Tilt Correction

Use the joystick to scroll up or down to correct any tilt of the picture from -5 to +5, then press .

Language

Display all menus in the language of your choice. Use the joystick to scroll up or down to select from one of the following options: English, Español (Spanish) and Français (French). Then press .

16:9 Enhanced

Provides enhanced picture resolution for wide-screen sources such as DVD (only available when the TV is in Video mode).

Demo

Press  to run a demonstration of the on-screen menus.

 You can press any key to exit Demo mode.

Using the Basic Menu

To access the Basic menu, refer to the following steps:



To Display **To Highlight**  **To Select**

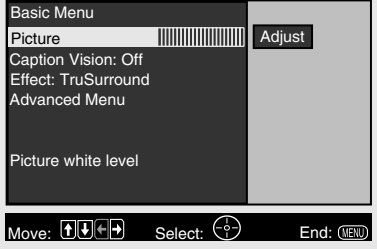

Press joystick \downarrow to highlight an option then press \odot .









Picture	Use joystick left to decrease picture contrast.
<i>Picture contrast</i>	Use joystick right to increase picture contrast.
Caption Vision	In the Basic menu, Caption Vision options are Off and the last captioning option selected (CC1-4, Text 1-4, or Info).
<i>Closed-Captioning</i>	
Effect	Use the joystick to scroll up or down to select one of the following options, then press \odot to select it.
Simulated:	Simulates theater quality sound for mono programs.
WOW:	Provides a dramatic presence with a full, deep bass sound. When WOW is enabled, BBE is directly activated to further enhance the audio performance.
TruSurround:	Produces a dynamic three dimensional sound for stereo audio signals.
Off:	Normal stereo or mono reception.
Advanced Menu	Press \odot to return to the advanced menus.

 If you use the  button to close the Basic menu, only the Basic menu appears when you press  again. To access the other menus, use the joystick to scroll down to highlight Advanced Menu, then press \odot .

Other Information

Programming the Remote Control

You can use the supplied remote control to operate Sony or non-Sony video equipment.

- 1 Press .
- 2 Press  or  (FUNCTION).
- 3 Use the - buttons to key in the code number from the following chart.
- 4 Press .

VCR codes

Sony	301, 302, 303	JCPenney	309, 305, 304, 330, 314, 336, 337
Admiral (M.Ward)	327	JVC	314, 336, 337, 345, 346, 347
Aiwa	338, 344	Kenwood	314, 336, 332, 337
Audio Dynamic	314, 337	LXI (Sears)	332, 305, 330, 335, 338
Broksonic	319, 317	Magnavox	308, 309, 310
Canon	309, 308	Marantz	314, 336, 337
Citizen	332	Marta	332
Craig	302, 332	Memorex	309, 335
Criterion	315	Minolta	305, 304
Curtis Mathis	304, 338, 309	Mitsubishi/MGA	323, 324, 325, 326
Daewoo	341, 312, 309	Multitech	325, 338, 321
DBX	314, 336, 337	NEC	314, 336, 337
Dimensia	304	Olympic	309, 308
Emerson	319, 320, 316, 317, 318, 341	Optimus	327
Fisher	330, 335	Panasonic	308, 309, 306, 307
Funai	338	Pentax	305, 304
General Electric	329, 304, 309	Philco	308, 309
Go Video	322, 339, 340	Philips	308, 309, 310
Goldstar	332	Pioneer	308
Hitachi	306, 304, 305, 338	Quasar	308, 309, 306
Instant Replay	309, 308	RCA/PROSCAN	304, 305, 308, 309, 311, 312, 313, 310, 329
Realistic	309, 330, 328, 335, 324, 338	Symphonic	338
Samsung	322, 313, 321	Tashiro	332
Sansui	314	Tatung	314, 336, 337
Sanyo	330, 335	Teac	314, 336, 338, 337

Operating Instructions

VCR codes

Scott	312, 313, 321, 335, 323, 324, 325, 326	Technics	309, 308
Sharp	327, 328	Toshiba	312, 311
Shintom	315	Wards	327, 328, 335, 331, 332
Signature 2000 (M.Ward)	338, 327	Yamaha	314, 330, 336, 337
SV2000	338	Zenith	331
Sylvania	308, 309, 338, 310		

Cable box codes

Sony	230
Hamlin/Regal	222, 223, 224, 225, 226
Jerrold/G. I.	201, 202, 203, 204, 205, 206, 207, 208, 218
Oak	227, 228, 229
Panasonic	219, 220, 221
Pioneer	214, 215
Scientific Atlanta	209, 210, 211
Tocom	216, 217
Zenith	212, 213

Laser Disc Player codes

Sony	701
Panasonic	704, 710
Pioneer	702

DBS codes

DIRECTV	809
Echostar/Dish Network	810

Satellite receiver codes

Sony	801
General Electric	802
Hitachi	805
Hughes	804
Panasonic	803
RCA/PROSCAN	802, 808
Toshiba	806, 807

DVD Player codes









Sony	751
JVC	756
Mitsubishi	761
Onkyo	762
Oritron	759
Panasonic	753
Philips/ Magnavox	757
Pioneer	752
RCA	755
Samsung/Hitachi	758
Toshiba	754
Zenith	760

 If more than one code number is listed, try entering them one by one until you come to the correct code for your equipment.









 Whenever you remove the batteries, the code numbers may revert to the factory setting and must be reset.

 In some rare cases, you may not be able to operate your equipment with the supplied remote control. In this case, use the equipment's supplied remote control.



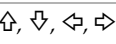

Operating a VCR

Press	To
	Power on the VCR
	Select channels directly
	Change channels
	Play video tape
	Stop
	Search forward or backward
	Pause
	Record
	Change between VCR and TV inputs

Operating a DVD

Press	To
	Power on the DVD
	Select chapters directly
	Search chapters forward or backward
	Play DVD
	Stop
	Pause
	Move the cursor in the menu
	Display the DVD menu



Operating a Laser Disc

Press	To
	Power on the laser disc
	Search chapters forward or backward
	Play disc
	Stop
	Pause

Troubleshooting

If you are having a problem with your TV, try the suggestions below. If the problem persists, contact your nearest Sony Dealer.

Problem	Possible Solutions
Reset the TV to factory settings	<ul style="list-style-type: none"> ❑ Turn on the TV. While holding down the RESET button on the remote control, press POWER button on the TV front panel. (The TV will turn itself off, then back on again.) Release the RESET button.
No picture, no sound	<ul style="list-style-type: none"> ❑ Make sure the power cord is plugged in. ❑ If a red light is flashing on the front of your TV for more than a few minutes, disconnect and reconnect the power cord to restore the TV. If the problem continues, call your local service center. ❑ Check the TV/VIDEO setting: when watching TV, set to TV; when watching video equipment, set to VIDEO 1, 2, 3 or 4 (page 4, 6). ❑ Make sure the batteries have been inserted correctly into the remote control (page 2). ❑ Try another channel to rule out station trouble.
Poor or no picture, good sound	<ul style="list-style-type: none"> ❑ Adjust the Picture setting in the Video menu (page 34). ❑ Adjust the Brightness setting in the Video menu (page 34). ❑ Check the antenna and/or cable connections (page 10).
Good picture, no sound	<ul style="list-style-type: none"> ❑ Press  so that Muting disappears from the screen (page 3 for remote Y181, page 5 for remote Y182). ❑ Check your Audio settings. Your TV may be set to Auto SAP in the MTS feature (page 36).
No color	<ul style="list-style-type: none"> ❑ Adjust the Color setting in the Video menu (page 34).
Only snow appears on the screen	<ul style="list-style-type: none"> ❑ Check the Cable setting in the Channel Setup menu (page 37). ❑ Check the antenna and/or cable connections (page 10). ❑ Make sure the channel selected is currently broadcasting.
Dotted lines or stripes	<ul style="list-style-type: none"> ❑ Adjust the antenna. ❑ Move the TV away from other electronic equipment. Some electronic equipment creates electrical noise, which can interfere with TV reception.
Double images or ghosts	<ul style="list-style-type: none"> ❑ Check your outdoor antenna or call your cable service.
Cannot receive higher number channels (UHF) when using an antenna	<ul style="list-style-type: none"> ❑ Make sure Cable is set to Off in the Channel Setup menu (page 37). ❑ Perform Auto Program to add channels that are not presently in the memory (page 21).

Problem	Possible Solutions
Cable stations don't seem to work	<ul style="list-style-type: none"> ❑ Make sure Cable is set to On in the Channel Setup menu (page 37). ❑ Perform Auto Program to add channels that are not presently in the memory (page 21).
Remote control does not operate	<ul style="list-style-type: none"> ❑ Press TV (FUNCTION) when operating your TV. ❑ Check the orientation of the batteries. ❑ Batteries could be weak. Replace them (page 2). ❑ Move the TV three to four feet away from fluorescent lights.
Cannot change channels with the remote control	<ul style="list-style-type: none"> ❑ Make sure you have not inadvertently switched your TV from the channel 3 or 4 setting if you are using another device to change channels. ❑ If you are using another device to control channels, be sure that you have pressed the FUNCTION button for that device. For example, if you're using your VCR to control channels, be sure to press the VCR/DVD FUNCTION buttons (page 3 for remote Y181, page 5 for remote Y182).
Cannot access other menus when using the Basic menu	<ul style="list-style-type: none"> ❑ If you use the  button to close the Basic menu, only the Basic menu appears when you press  again. To access the other menus, select the Advanced Menu option (page 47).
The remote control doesn't work in PIP mode	<ul style="list-style-type: none"> ❑ Press the TV FUNCTION button. You may have inadvertently pressed the VCR/DVD FUNCTION button, which changes the PIP buttons to VCR mode (page 24 for remote Y181, page 26 for remote Y182).
There is no window picture or it is just static	<ul style="list-style-type: none"> ❑ Be sure your PIP window picture is set to a video source/channel that has a program airing. ❑ You may be tuned to a video input with nothing connected to it. Try cycling through your video inputs using the yellow PIP TV/VIDEO button with the red dot (page 26 for remote Y182, page 24 for remote Y181).
I get the same program in the window picture as in the main picture	<ul style="list-style-type: none"> ❑ Both may be set to the same channel. Try changing channels in either the main picture or the window picture (page 26 for remote Y182, page 24 for remote Y181). ❑ Your TV may be set up to select all your channels through a cable box. The cable box will only unscramble one signal at a time, so you cannot use the PIP feature. If possible, run a direct cable to the VHF/UHF jack on your TV. This will only work if your cable system provides an unscrambled signal (page 12).

Operating Instructions

Problem	Possible Solutions
I cannot get anything but TV	<input type="checkbox"/> Be sure that you did not set the video label in the Setup menu (page 46) to skip your video inputs. If a video input is skipped, the problem will happen both in the main and PIP pictures.
The TV needs to be cleaned	<input type="checkbox"/> Clean the TV with a soft dry cloth. Never use strong solvents such as thinner or benzine, which might damage the finish of the cabinet.
Lost password for Parental Control	<input type="checkbox"/> In the password screen, enter the following master password: 4357. After using the master password, you must create a new password, it cannot be used to unlock currently blocked channels.
You lost your remote control	<input type="checkbox"/> You can use the front panel controls to access your menus, change channels, adjust the volume or change video inputs (page 2). Contact your nearest Sony Dealer to order a replacement, please call our Sony Direct Accessory and Part Center at 1-800-488-7669 (U.S. residents only).
There is a black box on the screen	<input type="checkbox"/> You have selected a text option in the Setup menu (page 46) and no text is available. To turn off this feature, select Off in the Caption Vision option. If you were trying to select closed captioning, select CC1 instead of Text 1-4.
TV doesn't turn on after disconnecting the TV and timer LED flashes	<input type="checkbox"/> Press the POWER button on your remote control or in the TV front panel, one more time.

If, after reading these Operating Instructions, you have additional questions related to the use of your Sony television, please call our Customer Information Services Center at 1-800-222-SONY (7669) (U.S. residents only) or (416) 499-SONY (7669) (Canadian residents only).

Specifications

For all models (except as noted)

Television system	American TV standard/NTSC (KV-27FV300, KV-32FV300, KV-36FV300)
Channel coverage	VHF: 2-13/UHF: 14-69/CATV: 1-125
Antenna	75-ohm external antenna terminal for VHF/UHF
Picture tube	FD Trinitron® tube
Power requirements	120V, 60 Hz (KV-27FV300, KV-32FV300, KV-36FV300)
Supplied Accessories	Size AA (R6) batteries (2) Remote Control RM-Y181 (1) (KV-27FV300) Remote Control RM-Y182 (1) (KV-32FV300 and KV-36FV300) Wireless Headphones (1) (KV-32FV300 and KV-36FV300)
Optional Accessories	TV Stand: SU-27HV1 for KV-27FV300, SU-32HV1 for KV-32 FV300 SU-36HV1 for KV-36FV300

KV-27FV300

Screen size	Visible screen size: 679 mm (27 inches) measured diagonally Actual screen size: 736,6 mm (29 inches) measured diagonally
Inputs/outputs	Inputs 3 video, 3 audio Outputs 2 S VIDEO 1 AUDIO OUT 2 RF Inputs 1 MONITOR OUT 1 Y, Pb,Pr, 1 audio
Speaker output	7.5 W x 2, 15 W subwoofer
Power Consumption	220 W in use 1 W in standby
Dimensions (W/H/D)	784 x 601.5 x 520 mm (30 ⁷ / ₈ x 23 ¹¹ / ₁₆ x 20 ¹ / ₂ inches)
Mass	48 kg (105 lbs. 13 oz.)

KV-32FV300

Screen size	Visible screen size: 803 mm (32 inches) measured diagonally Actual screen size: 863,6 mm (34 inches) measured diagonally
Inputs/outputs	Inputs 3 video, 3 audio Outputs 2 S VIDEO 1 AUDIO OUT 2 RF Inputs 1 MONITOR OUT 1 Y, Pb,Pr, 1 audio
Speaker output	7.5 W x 2, 15 W subwoofer
Power Consumption	230 W in use 1 W in standby
Dimensions (W/H/D)	898 x 682 x 584 mm (35 ³ / ₈ x 26 ⁷ / ₈ x 23 inches)
Mass	78 kg (171 lbs. 15oz.)

KV-36FV300

Screen size	Visible screen size: 911 mm (36 inches) measured diagonally Actual screen size: 965.2 mm (38 inches) measured diagonally
Inputs/outputs	Inputs 3 video, 3 audio Outputs 2 S VIDEO 1 AUDIO OUT 2 RF Inputs 1 MONITOR OUT 1 Y, Pb,Pr, 1 audio
Speaker output	7.5 W x 2, 15 W subwoofer
Power Consumption	230 W in use 1 W in standby
Dimensions (W/H/D)	1020 x 760 x 640 mm (40 ¹ / ₄ x 30 x 25 ¹ / ₄ inches)
Mass	102 kg (224 lbs. 14oz.)

Design and specifications are subject to change without notice.

Index

- 16:9 Enhanced **46**
- A**
 - Audio Out **36**
 - Auto Program **21, 38**
 - Auto SAP **36**
- B**
 - Balance **35**
 - Bass **35**
 - Batteries
 - Inserting in remote **2**
 - Inserting in wireless headphones **29**
 - Brightness **34**
- C**
 - Cable **37**
 - Caption Vision **46**
 - Channel Fix **37**
 - Channel Label **38**
 - Channel Skip/Add **38**
 - ClearEdge VM **34**
 - Color **34**
 - Color Temperature **34**
 - Connections
 - Cable and antenna **10**
 - Cable Box and Cable **11**
 - Connecting a Camcorder **19**
 - Connecting a DVD Player **18**
 - Connecting an Audio System **19**
 - Connecting Two VCRs **15**
 - TV and Cable Box **11**
 - TV and Satellite Receiver **16**
 - TV and VCR **13**
 - TV, Satellite Receiver and VCR **17**
 - TV, VCR and Cable Box **14**
 - Current Time **45**
- D**
 - Demo **46**
 - DISPLAY
 - RM-Y-181 **5**
 - RM-Y182 **5**
 - DynaBlack **34**
- E**
 - Effect
 - Off **35**
 - Simulated **35**
 - TruSurround **35**
 - WOW **35**
- F**
 - Favorite Channels **37**
- H**
 - Hue **34**
- L**
 - Language **46**
- M**
 - Menus
 - Audio **35**
 - Basic **47**
 - Channel Setup **37**
 - Parent **39**
 - Setup **46**
 - Timer **45**
 - Video **34**
 - Mode
 - Movie **34**
 - Sports **34**
 - Standard **34**
 - Vivid **34**
 - MTS
 - Auto SAP **36**
 - Mono **36**
 - Stereo **36**
- P**
 - Parental Control **40**
 - Picture **34**
 - Picture in Picture (PIP)
 - RM-181 **24**
 - RM-Y182 **26**
- R**
 - Ratings
 - English Rating **44**
 - French Rating **44**
 - Movie Rating **42**
 - TV Rating **42**
 - U.S.A. Rating **42**
 - Unrated **43**
 - Remote Control
 - Programming **49**
 - RM-Y181 **5**
 - RM-Y182 **5**

S

Setting the Rating **40**

Sharpness **34**

SLEEP

RM-181 **5**

RM-Y182 **5**

Speaker **36**

Specifications **55**

Steady Sound **35**

T

Tilt Correction **46**

Timer 1 and Timer 2 **45**

Treble **35**

Troubleshooting **52**

TV Features **1**

TV Front Panel **2**

TV Rear Panel **8**

V

V-Chip (see Parental Control)

Video Label **46**

W

Wireless Headphones

Batteries **29**

PIP **31**

